

# Data Sheet

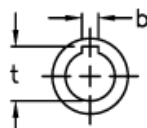

Article number: 2301077821  
Description: E+G Handwheel  
VR.300 FP+I

## Measures

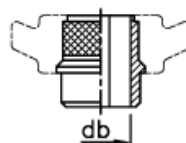
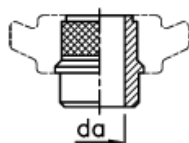
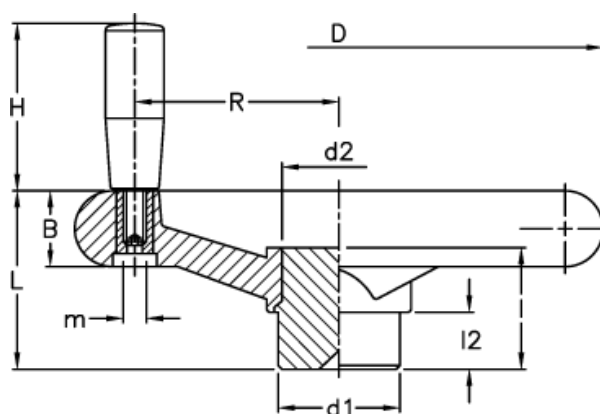

da max tilladelig boring uden not

db max tilladelig boring med not

b	= 10	H	= 100
B	= 32	l	= 56
C (N m)	= 800	L	= 78
D	= 288	L (J)	= 33
d1	= 58	l2	= 18
d2	= 47	m	= M12
da	= 42	R	= 113
db	= 34	t	= 37.3